

# FRIGIDAIRE®

## FPDP2919-D10

### 16 Gauge 304 Stainless Steel Single Bowl Undermount Sink

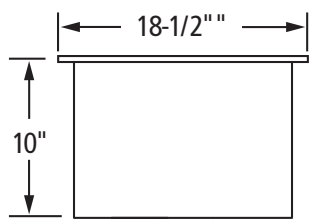
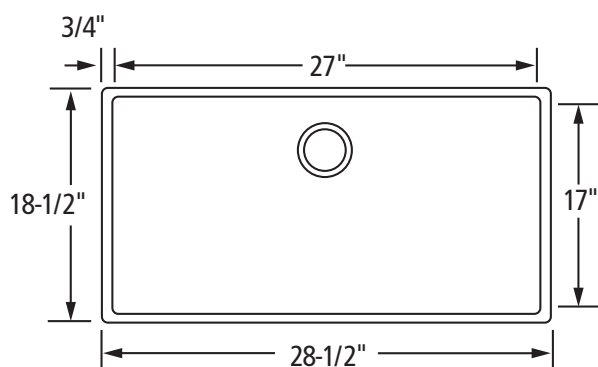
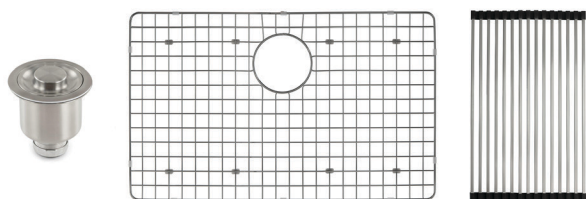

Side View

#### Dimensions

- Overall Size: 28-1/2" x 18-1/2"
- Bowl: 27" x 17" x 10"
- Drain Opening: 3-1/2"

#### Included Accessories

- Grid
- Sink Strainer
- Roll mat

#### Features

- Handmade
- 10 MM radius corners
- 16 gauge 304 stainless steel
- Proprietary V-Therm Shield™
  - Provides superior sound deadening and thermal retention
- Long lasting, tight brush finish
- Stain and corrosion resistant

#### Lifetime Warranty

Complies with ASME A112.19.3-2000

All sinks are handmade. Prior to cutting, verify with included template.