

FRIGIDAIRE®

FPDP1919-D10

16 Gauge 304 Stainless Steel Single Bowl Undermount Sink

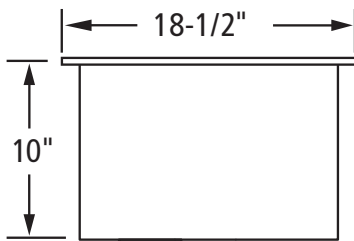
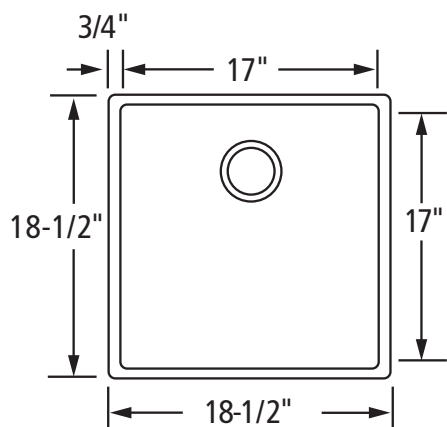

Side View

Dimensions

- Overall Size: 18-1/2" x 18-1/2"
- Bowl: 17" x 17" x 10"
- Drain Opening: 3-1/2"

Included Accessories

- Grid
- Sink strainer
- Roll mat

Features

- Handmade
- 10 MM radius corners
- 16 gauge 304 stainless steel
- Proprietary V-Therm Shield™
 - Provides superior sound deadening and thermal retention
- Long lasting, tight brush finish
- Stain and corrosion resistant

Lifetime Warranty

Complies with ASME A112.19.3-2000

All sinks are handmade. Prior to cutting, verify with included template.